

# KINGS HILL CONDOMINIUMS

LOCATED IN  
 A PORTION OF BLOCK 6, "JOHNSON'S ADDITION TO THE CITY OF PORTLAND"  
 AND IN THE SOUTHWEST 1/4 OF SECTION 33, TOWNSHIP 1 NORTH, RANGE 1 EAST, W.M.  
 CITY OF PORTLAND, MULTNOMAH COUNTY, OREGON

DATE OF MONUMENTATION June 30, 1985

PREPARED BY  
 ROBERT E. METER CONSULTANTS, INC  
 4915 S.W. GRIFFITH DRIVE, # 300  
 BEAVERTON, OREGON 97005  
 PH (503) 643-7531  
 PROJECT NO. 1711-04

## REFERENCE DATA

- A) SN 48906, 15619, 43479, 35672
- B) PLAT OF JOHNSON'S ADDITION TO THE CITY OF PORTLAND, PLAT BOOK 1, PAGE 81
- C) WARRANTY DEED, FEE NO. 95-38152

## INDEX

- SHEET 1 - SURVEYOR'S CERTIFICATE, MAP, NARRATIVE
- SHEET 2 - 1<sup>ST</sup> FLOOR UNITS, 2<sup>ND</sup> & 3<sup>RD</sup> FLOOR UNITS
- SHEET 3 - 4<sup>TH</sup> FLOOR UNITS, ATTIC
- SHEET 4 - DECLARATION, ACKNOWLEDGEMENT, CONSENT AFFIDAVITS, APPROVALS

## NARRATIVE

I, G. ROBERT TAYLOR, A REGISTERED PROFESSIONAL LAND SURVEYOR, HEREBY CERTIFY THIS MAP REPRESENTS A SURVEY MADE BY ME OR UNDER MY DIRECTION AT THE REQUEST OF ROBERT E. METER CONSULTANTS, INC. THE PURPOSE OF THIS SURVEY IS TO ESTABLISH THE BOUNDARY OF SAID LAND FOR A CONDOMINIUM PLAT.

AS A BASIS OF BEARING I HELD A BEARING OF WEST ALONG THE SOUTH LINE OF BLOCK 6 OF "JOHNSON'S ADDITION TO THE CITY OF PORTLAND" AND CALLED OUT ON SURVEY NUMBER (SN) 43479 AND SN 48906 AND FURTHER I HELD A FOUND BRASS SCREW WHICH IS ON A 4.00 FOOT OFFSET LINE TO THE SOUTHEAST CORNER OF SAID BLOCK 6.

TO ESTABLISH THE SOUTH LINE OF THIS TRACT I HELD THE SAID FOUND BRASS SCREW AT THE 4.00 FOOT OFFSET LINE TO THE SOUTHEAST CORNER OF BLOCK 6 AND FOUND BRASS SCREW 71.00 FEET WEST WHICH IS ON A 4.00 FOOT OFFSET LINE TO THE SOUTHWEST CORNER OF THIS TRACT.

TO ESTABLISH THE WEST LINE OF THIS TRACT I HELD THE FOUND BRASS SCREW ON A 4.00 FOOT OFFSET LINE AT THE SOUTHWEST CORNER OF THIS TRACT AND WENT NORTH FEELING FOR A YELLOW PLASTIC CAP. I FOUND THE CAP AND FROM THE NORTHWEST CORNER I FOUND A 5/8" IRON ROD WITH YELLOW PLASTIC CAP MARKED "R.A. LAWRENCE" BEARS SOUTH 0.18 FEET FROM THE NORTHWEST CORNER OF SAID TRACT.

THE NORTH AND EAST LINES WERE ESTABLISHED BY HOLDING THE DISTANCES CALLED FOR IN A WARRANTY DEED AND DESCRIBED IN FEE NO. 95-38152 WHICH WERE THE EAST 67.00 FEET OF THE SOUTH 100.00 FEET OF SAID BLOCK 6.

THIS SITE CONTAINS 6700 SQUARE FEET.

## SURVEYOR'S CERTIFICATE

I, G. ROBERT TAYLOR, A REGISTERED PROFESSIONAL LAND SURVEYOR, HEREBY CERTIFY THAT I HAVE CORRECTLY SURVEYED AND MARKED WITH PROPER MONUMENTS THE LANDS REPRESENTED ON THE ANNEKED MAP OF "KINGS HILL CONDOMINIUMS" SITUATED IN THE SOUTHWEST 1/4 OF SECTION 33, TOWNSHIP 1 NORTH, RANGE 1 EAST, WILLAMETTE MERIDIAN, CITY OF PORTLAND, MULTNOMAH COUNTY, OREGON, AND BEING MORE PARTICULARLY DESCRIBED AS FOLLOWS:

BEGINNING AT THE SOUTHEAST CORNER OF BLOCK 6 OF "JOHNSON'S ADDITION TO THE CITY OF PORTLAND", RECORDED IN PLAT BOOK 1 AT PAGE 81 OF THE MULTNOMAH COUNTY RECORDS, SAID POINT BEING THE INITIAL POINT OF THIS PLAT BEARS NORTH 80.00' AND EAST 300.00' FROM A 5/8" IRON ROD WITH YELLOW PLASTIC CAP MARKED "R.A. LAWRENCE" FOUND AT THE NORTH WEST CORNER OF "THE LIPMAN HOUSE CONDOMINIUM AND FURTHER FROM SAID POINT I FOUND A BRASS PLUG IN LEAD SOUTH 4.00 FEET AND EAST 4.00 FEET, THENCE FROM THE INITIAL POINT WEST ALONG THE SOUTH LINE OF SAID BLOCK 6 BEARS SOUTH 71.00 FEET FROM WHICH A BRASS SCREW IN CONCRETE BEARS SOUTH 71.00 FEET FROM WHICH A BRASS LINE IS 67.00 FEET WEST OF AND PARALLEL WITH THE EAST LINE OF SAID BLOCK 6 100.00 FEET FROM WHICH I FOUND A 5/8" IRON ROD SOUTH 0.18 FEET; THENCE EAST 67.00 FEET TO THE EAST LINE OF SAID BLOCK 6 FROM WHICH A LEAD PLUG WITH A PUNCH MARK BEARS EAST 5.08 FEET AND SOUTH 0.14 FEET; THENCE SOUTH ALONG THE EAST LINE OF SAID BLOCK 6 100.00 FEET TO THE INITIAL POINT AND POINT OF BEGINNING. CONTAINS 6700.00 SQUARE FEET.

REGISTERED PROFESSIONAL LAND SURVEYOR  
 G. ROBERT TAYLOR  
 OREGON  
 JUL 17, 1980  
 EXPIRES  
 RENEWAL DATE  
 JUNE 30, 1988

I HEREBY CERTIFY THAT THIS TRACING IS A TRUE AND EXACT COPY OF THE ORIGINAL PLAT OF "KINGS HILL CONDOMINIUMS."

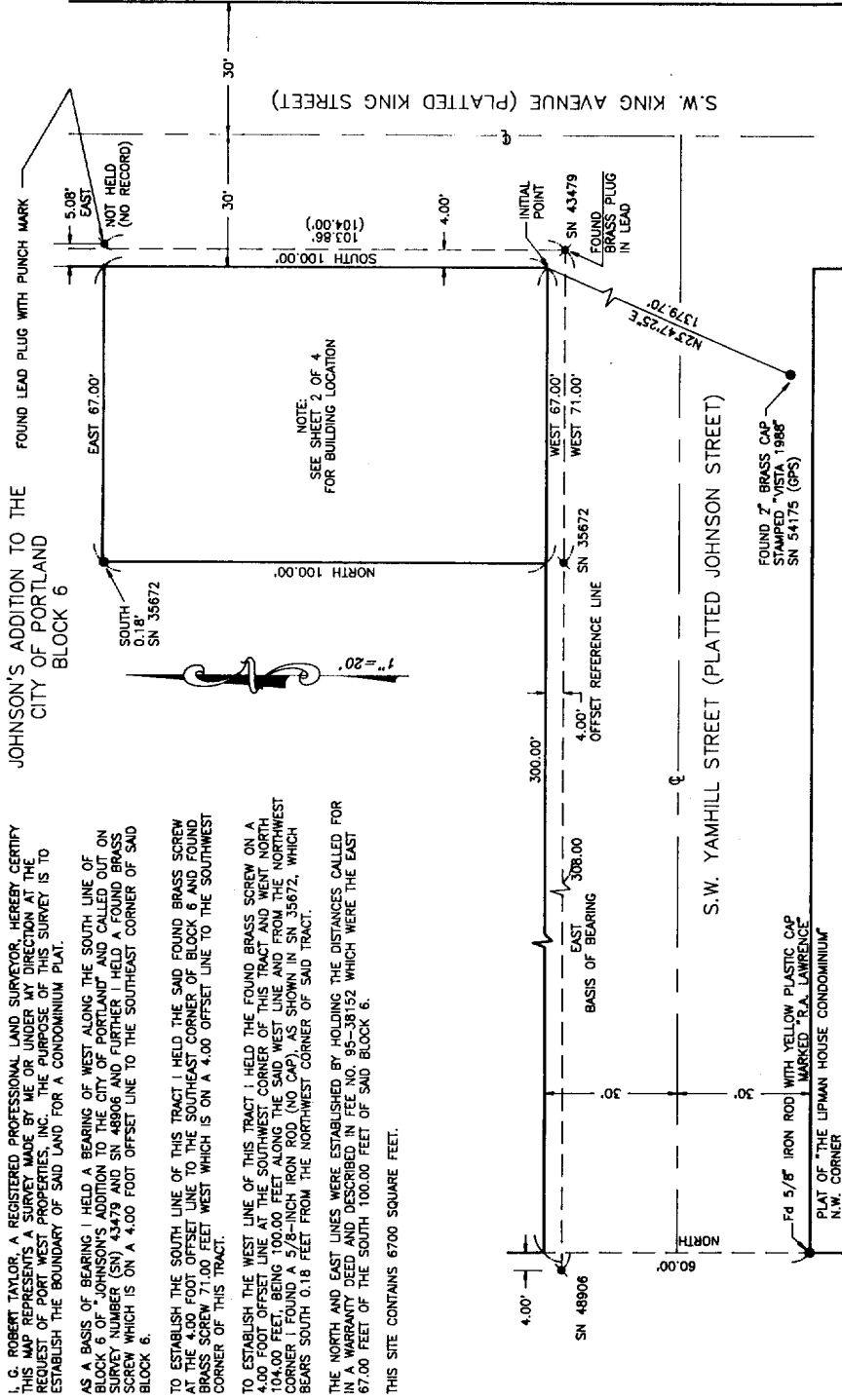

# KINGS HILL CONDOMINIUMS

LOCATED IN  
 A PORTION OF BLOCK 6, "JOHNSON'S ADDITION TO THE CITY OF PORTLAND"  
 AND IN THE SOUTHWEST 1/4 OF SECTION 33, TOWNSHIP 1 NORTH, RANGE 1 EAST, W.M.  
 CITY OF PORTLAND, MULTNOMAH COUNTY, OREGON

DATE OF MONUMENTATION June 30, 1975

PREPARED BY  
 ROBERT E. MEYER CONSULTANTS, INC  
 4915 S.W. GRIFFITH DRIVE, # 300  
 BEAVERTON, OREGON 97005  
 PH (503) 643-7531  
 PROJECT NO. 1711-04

SURVEYOR'S CERTIFICATE OF COMPLETION  
 I, G. ROBERT TAYLOR, A REGISTERED PROFESSIONAL LAND SURVEYOR,  
 HEREBY CERTIFY THAT THE PLAN OF "KINGS HILL CONDOMINIUMS"  
 FULLY AND ACCURATELY DEPICTS THE BOUNDARIES OF THE UNITS  
 AND THE BUILDINGS, AS DEPICTED ON SUCH PLAN, HAVE BEEN  
 COMPLETED.  
 DATED THIS 15 DAY OF JULY, 1985

## LEGEND

- GCE GENERAL COMMON ELEMENT
- LCE LIMITED COMMON ELEMENT
- SQ. FT. SQUARE FOOTAGE OF UNIT
- F.F. EL. FINISH FLOOR ELEVATION
- B/B BUILDING TO BOUNDARY DISTANCE
- ADJ. BUILDING DOES NOT ENCRoACH ONTO ADJ. ADJOURNER

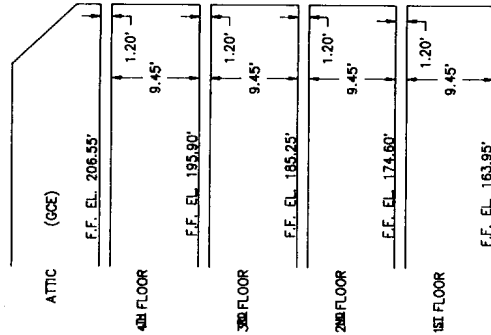

## VERTICAL SECTION (A)

BASIS OF DATUM:  
 BASED ON CITY OF PORTLAND  
 BENCH MARK NO. 40  
 ELEVATION: 136.43'

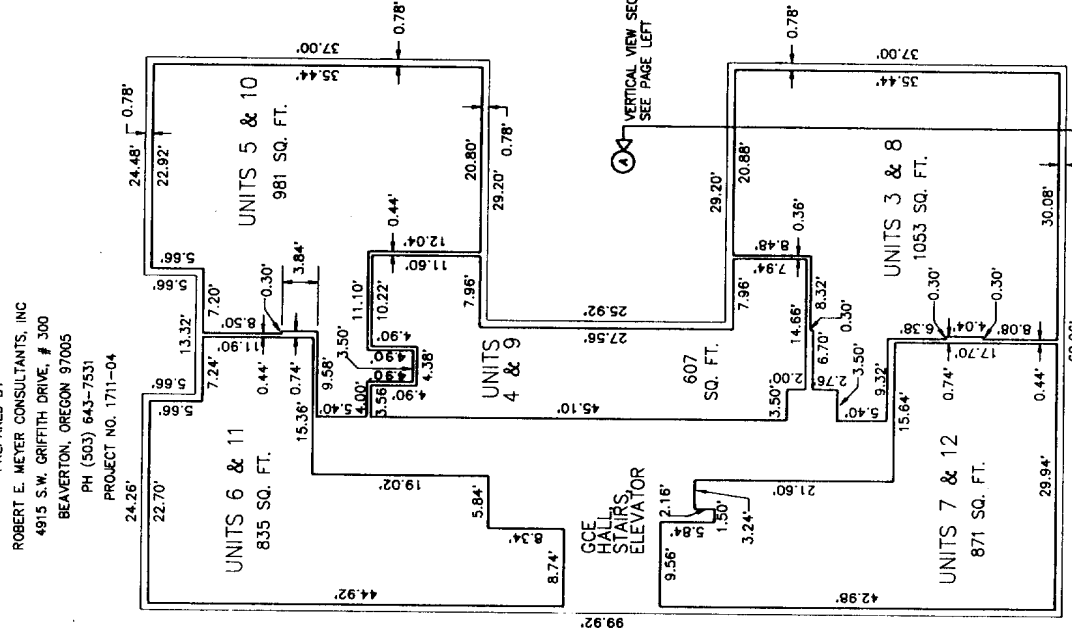
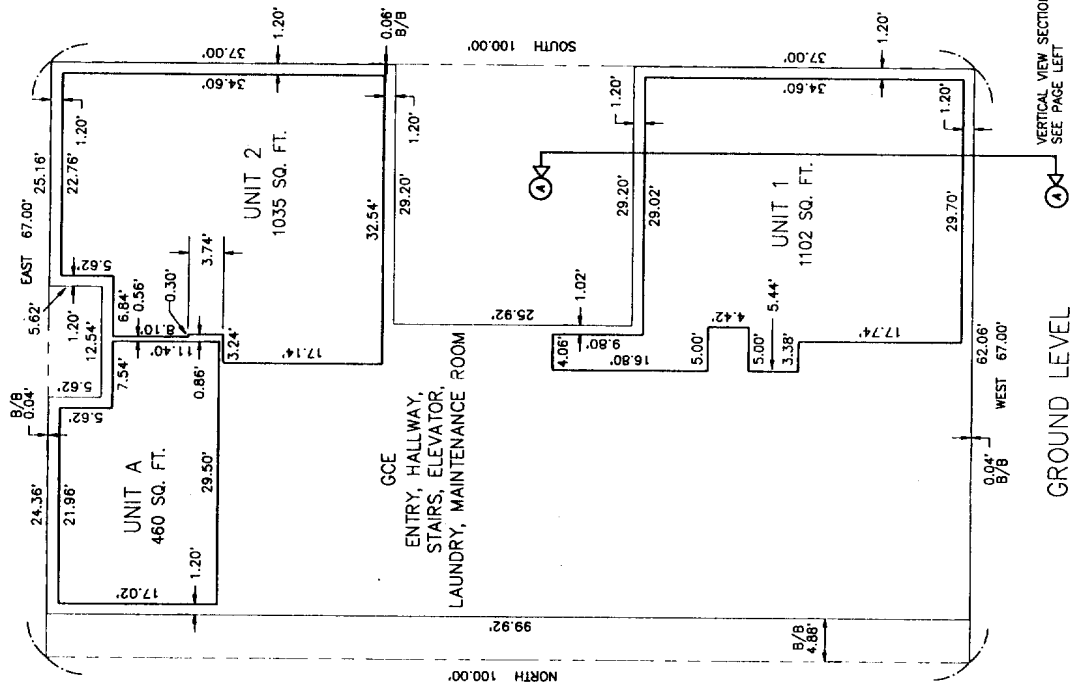

HEREBY CERTIFY THAT THIS  
 TRACING IS A TRUE AND EXACT  
 COPY OF THE ORIGINAL PLAT OF  
 "KINGS HILL CONDOMINIUMS"

REGISTERED  
 PROFESSIONAL  
 LAND SURVEYOR  
 G. ROBERT TAYLOR  
 OREGON  
 JULY 17, 1976  
 EXPIRES DATE  
 JUNE 30, 1986

**LEGEND**

- GCE GENERAL COMMON ELEMENT
- LCE LIMITED COMMON ELEMENT
- SQ. FT. SQUARE FOOTAGE OF UNIT

SURVEYOR'S CERTIFICATE OF COMPLETION  
 I, G. ROBERT TAYLOR, A REGISTERED PROFESSIONAL LAND SURVEYOR,  
 HEREBY CERTIFY THAT THE PLAT OF "KINGS HILL CONDOMINIUMS"  
 FULLY AND ACCURATELY DEPICTS THE BOUNDARIES OF THE UNITS  
 AND THE BUILDINGS, AS DEPICTED ON SUCH PLAT, HAVE BEEN  
 COMPLETED.  
 DATED THIS 17 DAY OF July, 1995

**KINGS HILL CONDOMINIUMS**

LOCATED IN  
 A PORTION OF BLOCK 6, "JOHNSON'S ADDITION TO THE CITY OF PORTLAND"  
 AND IN THE SOUTHWEST 1/4 OF SECTION 33, TOWNSHIP 1 NORTH, RANGE 1 EAST, W.M.  
 CITY OF PORTLAND, MULTNOMAH COUNTY, OREGON

DATE OF MONUMENTATION June 30, 1995

NOTE: INTERIOR WALLS OF UNITS ARE PARALLEL  
 WITH EXTERIOR OF BUILDING

PREPARED BY  
 ROBERT E. MEYER CONSULTANTS, INC  
 4915 S.W. GRIFFITH DRIVE, # 300  
 BEAVERTON, OREGON 97005  
 PH (503) 643-7531  
 PROJECT NO. 1711-04

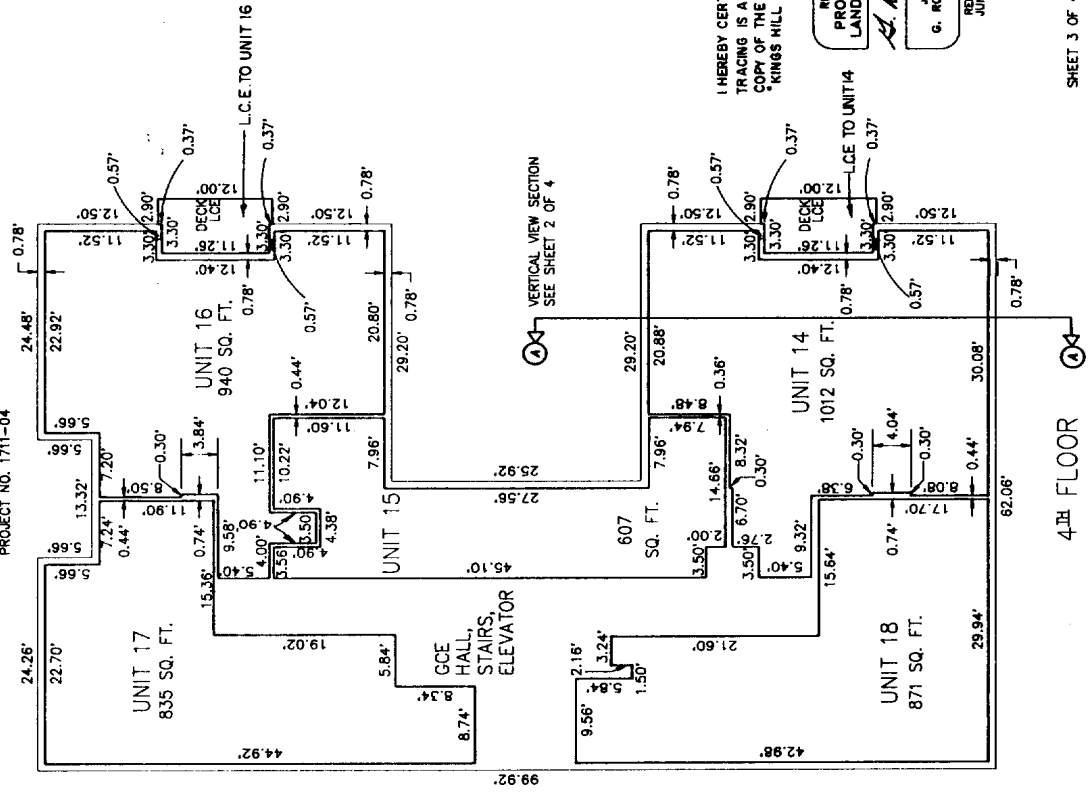
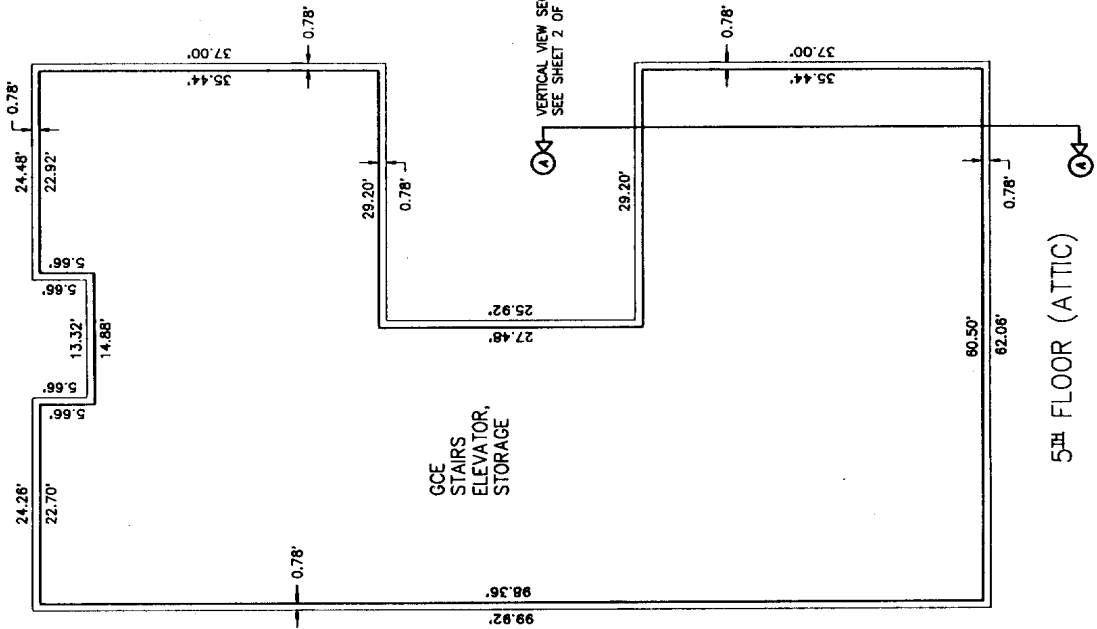

HEREBY CERTIFY THAT THIS  
 TRACING IS A TRUE AND EXACT  
 COPY OF THE ORIGINAL PLAT OF  
 "KINGS HILL CONDOMINIUMS"

REGISTERED  
 PROFESSIONAL  
 LAND SURVEYOR  
 G. Robert Taylor  
 OREGON  
 JULY 17, 1970  
 RENEWAL DATE:  
 JUNE 30, 1995

# KINGS HILL CONDOMINIUMS

LOCATED IN  
A PORTION OF BLOCK 6, "JOHNSON'S ADDITION TO THE CITY OF PORTLAND"  
AND IN THE SOUTHWEST 1/4 OF SECTION 33, TOWNSHIP 1 NORTH, RANGE 1 EAST, W.M.  
CITY OF PORTLAND, MULTNOMAH COUNTY, OREGON  
DATE OF MONUMENTATION June 30, 1995

PREPARED BY  
ROBERT E. MEYER CONSULTANTS, INC  
4915 S.W. GRIFFITH DRIVE, # 300  
BEAVERTON, OREGON 97005  
PH (503) 643-7531  
PROJECT NO. 1711-04

## DECLARATION

KNOW ALL PERSONS BY THESE PRESENTS, THAT KINGS HILLS PROJECT L.L.C.  
AN OREGON LIMITED LIABILITY COMPANY,  
IS THE OWNER OF THE LANDS DESCRIBED IN THE ACCOMPANYING SURVEYOR'S CERTIFICATE AND DOES  
HEREBY DECLARE THE ANNEXED MAP "KINGS HILL CONDOMINIUMS" TO BE TRUE AND CORRECT, AND  
DOES HEREBY COMMIT SAID PROPERTY TO THE OPERATION AND PROVISIONS OF THE OREGON  
CONDOMINIUM ACT. THERE ARE NO WATER RIGHTS APPURTENANT TO THIS PROPERTY.

EXECUTED THIS 19 DAY OF September, 19 95

Gregory P. Dainiec  
KINGS HILLS PROJECT LIMITED LIABILITY COMPANY  
GREGORY P. DAINIEC, PRESIDENT OF PORT WEST PROPERTIES,  
MANAGING AGENT OF KINGS HILLS PROJECT L.L.C.

## ACKNOWLEDGEMENT

STATE OF OREGON }  
MULTNOMAH COUNTY } SS

THIS CERTIFIES THAT ON THIS 19 DAY OF September, 19 95.

BEFORE ME THE UNDERSIGNED, A NOTARY PUBLIC IN AND FOR THE STATE AND COUNTY, PERSONALLY  
APPEARED GREGORY P. DAINIEC, WHO BEING DULY SWORN, DID SAY THAT HE IS THE PRESIDENT OF  
PORT WEST PROPERTIES, INC., AND THE SAID INSTRUMENT WAS SIGNED ON BEHALF OF SAID LIMITED LIABILITY COMPANY  
BY THE AUTHORITY OF ITS BOARD OF DIRECTORS, AND DOES ACKNOWLEDGE SAID INSTRUMENT TO BE A  
FREE ACT AND DEED.



Gregory P. Dainiec  
NOTARY PUBLIC FOR THE STATE OF OREGON  
\* WHICH IS THE MANAGING AGENT FOR KINGS HILLS PROJECT L.L.C.

## APPROVALS

APPROVED September 22, 1995  
CITY OF PORTLAND, BUREAU OF BUILDING  
BY: Margaret M. Mackenzie

APPROVED September 27, 1995  
COUNTY SURVEYOR, MULTNOMAH COUNTY, OREGON  
BY: Olan A. Young - DEPUTY

ALL TAXES, FEES, ASSESSMENTS OR OTHER CHARGES AS PROVIDED  
BY O.R.S. 100.110 HAVE BEEN PAID AS OF September 22, 1995  
DIRECTOR, DIVISION OF ASSESSMENT AND TAXATION  
MULTNOMAH COUNTY, OREGON

BY: Robert B. Smith  
DEPUTY  
STATE OF OREGON )  
MULTNOMAH COUNTY ) SS

I DO HEREBY CERTIFY THAT THE ATTACHED CONDOMINIUM PLAT WAS  
RECEIVED FOR RECORD AND RECORDED September 27, 1995  
AT 2:37 P.M. IN BOOK 1229 ON PAGES 87-90.  
COUNTY RECORDING OFFICE: 1111

BY: W. Wallace  
DEPUTY  
DOCUMENT NO. 95-118108

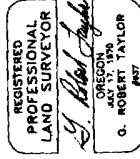

I HEREBY CERTIFY THAT THIS  
TRACING IS A TRUE AND EXACT  
COPY OF THE ORIGINAL PLAT OF  
"KINGS HILL CONDOMINIUMS"

This instrument filed for record by  
Fidelity National Title Company as an  
accommodation copy, if has not been  
examined as to its correctness or as to  
its effect upon the title.

AMENDMENT  
TO DECLARATION  
SUBMITTING  
KINGS HILL CONDOMINIUMS  
TO CONDOMINIUM OWNERSHIP

This amendment to the above-referenced Declaration is made pursuant to the provisions of the Oregon Condominium Act by the Association of Unit Owners of the Kings Hill Condominiums, the successor in interest to Kings Hill Project, L.L.C., an Oregon Limited Liability Company, the Declarant under said Declaration.

Pursuant to Section 13 of the above-referenced Declaration; Page 2, Section 4.2 entitled General Description, Location and Designation of Units is hereby amended to state as follows:

4.2 General Description, Location and Designation of Units. The condominiums consist of a total of eighteen (18) units. The average area of the units is 1040 square feet. Each unit has a kitchen, living room, bedroom, bathroom. Some of the floors are hardwood surfaced. The walls and ceilings are covered by "popcorn-style" acoustic or painted plaster. The dimensions, designation and location of each unit are shown in the plans recorded simultaneously herewith. A general description and the approximate square footage of each unit is shown on Exhibit B attached hereto.

In addition, Page 5, Section 12 entitled Adoption of Bylaws, Appointment of Interim Board, and Designation of Manager is hereby amended to state as follows:

12. Adoption Of Bylaws, Appointment Of Interim Board, And Designation Of Manager. Upon the execution and the filing of this Declaration, the Declarant shall adopt Bylaws for the Association of Unit Owners of Kings Hill Condominiums, which Bylaws are attached hereto as Exhibit "C" and are filed simultaneously herewith. At the same time, Declarant will appoint an interim Board of Directors of the Association, which directors shall serve until their successors have been elected as provided in the Bylaws. Such interim board of directors may appoint a manager or managing agent for the condominiums on behalf of the association of unit owners, and such manager or managing agent shall have complete authority to assume full control and responsibility for the management, operation and maintenance of the condominiums, at the expense of the association, from the date of its appointment. Each unit owner shall be a member of the association. Notwithstanding any other provision of this section, any management agreement or other contract providing for services by Declarant shall provide for termination on ninety (90) days' written notice and shall have a maximum contract term of three (3) years.

AMENDMENT TO DECLARATION  
KINGS HILL CONDOMINIUMS

AC 2000 8/13/309 FIDELITY NATIONAL TITLE

IN WITNESS WHEREOF, the Association of Unit Owners of the Kings Hill Condominiums has caused this Amendment to be executed on the \_\_\_\_\_ day of October, 1995, and does certify that it has been adopted in accordance with the Declaration and the provisions of ORS.100.135.

The Association Of Unit Owners  
Of Kings Hill Condominiums

By: 

Kings Hill Project, L.L.C.,  
an Oregon Limited Liability Company  
Its: Chairperson & Secretary  
By Port West Properties, Inc.  
Gregory P. Dolinajec, President  
Its: Managing Agent

AMENDMENT TO DECLARATION  
KINGS HILL CONDOMINIUMS

11/28/95

2

2

NOVEMBER 28, 1995

The foregoing Amendment to the Declaration is approved pursuant to ORS 100.110 this 20th day of November, 1995.

SCOTT W. TAYLOR  
Real Estate Commissioner

By: *John V. Mayfield*

STATE OF OREGON }  
Multnomah County }

I, a Deputy for the Recorder of Conveyances, in and for said County, do hereby certify that the within instrument of recording was received for record and recorded in the record of said County.

95 NOV 28 AM 10: 01

RECORDED & INDEXED  
MULTNOMAH COUNTY, OREGON

Serial Page  
95 147394

Witness my hand and seal of office at Salem,  
Recorder of Conveyances

*C Swick*

Deputy

3

*533*

RETURN TO: FIDELITY NATIONAL  
401 S.W. 4TH AVE  
PORTLAND, OR 97204  
ATTN: LAND DEVELOPMENT

**EXHIBIT C**

**BYLAWS OF THE ASSOCIATION OF UNIT OWNERS OF  
KINGS HILL CONDOMINIUMS**

Filed by:  
Kings Hill Project, L.L.C.,  
an Oregon Limited Liability Company

**ARTICLE I**

**PLAN OF UNIT OWNERSHIP**

1. Name and Location. These are the Bylaws of the ASSOCIATION OF UNIT OWNERS OF KINGS HILL CONDOMINIUMS (hereinafter the "Association"). KINGS HILL CONDOMINIUMS, (hereinafter the "condominiums") are located in the City of Portland, Multnomah County, Oregon, and have been submitted to the Oregon Condominium Act by a Declaration filed simultaneously herewith (hereinafter called the "Declaration"). The location of the condominiums is more specifically described in the Declaration.

2. Principal Office. The principal office of the Association shall be located at 731 S.W. King #14, Portland, Oregon.

3. Purposes. This Association is formed under the provisions of the Oregon Condominium Act to serve as the means through which the unit owners may take action with regard to the administration, management and operation of the condominiums. The Association will be an unincorporated association.

4. Applicability of Bylaws. The Association, all unit owners and all persons using the condominium property shall be subject to these Bylaws and to all rules and regulations which may be promulgated hereunder.

5. Personal Application. All present or future owners, tenants, future tenants or their employees, or any other person that might use the facilities of said real property in any manner, are subject to the regulations set forth in these Bylaws and to the restrictions, provisions, conditions and regulations set forth in the recorded Declaration.

The mere acquisition or rental of any of the units (as defined in the recorded Declaration) of said real property or the

KINGS HILL CONDOMINIUMS  
BYLAWS MAY 24, 1995

1 of 26

95 118110



mere act of occupancy of any of said units will signify that these Bylaws and the provisions of the recorded Declaration are accepted, ratified and will be complied with.

6. Composition of Association. The Association shall be composed of all the unit owners of the condominiums, including Port West Properties, Inc., an Oregon corporation, its successors and assigns (hereinafter, the "developer"), and the Association, itself, to the extent any of these own any unit or units of the condominiums.

7. Definitions.

(a) Adoption by Reference. The definitions contained in or adopted by the Declaration shall be applicable to these Bylaws.

(b) Percentage of Unit Owners. Whenever a percentage of unit owners is specified herein, such percentage means the owners of that percentage of the total number of unit owners existing in the condominium except that where there are multiple owners of a single unit all such owners taken together shall constitute one owner for the purpose of calculating the percentage.

(c) Mortgage and Mortgagee. As used herein, the terms "mortgage" and "mortgagee" shall include, respectively, a deed of trust and the beneficiary of a deed of trust.

ARTICLE II

TRANSITIONAL COMMITTEE

1. Formation of Transitional Committee. Unless the turnover meeting pursuant to Article III hereinbelow has been held, the developer shall call a meeting of the unit owners for the purpose of forming a transitional committee in accordance with the Bylaws of the condominiums. The developer shall call such meeting within sixty (60) days of conveyance to persons other than the developer of fifty percent (50%) of the units.

2. Powers of Committee. The transitional committee shall be advisory only and shall consist of two or more members selected by majority vote of the unit owners other than the developer and may include not more than one representative of the developer. The members shall serve until the turnover meeting. The function of the committee shall be that of enabling ease of transition from control of the administration for the Association of unit owners by the developer to control by the unit owners. The committee shall have access to the information, documents and

records which the developer must turn over to the Association pursuant to ORS § 100.210(5).

3. Notice of Meeting. The developer shall give notice of the transitional committee meeting in accordance with the Bylaws of the condominium to each unit owner at least seven (7) but not more than fifty (50) days prior to the meeting. The notice shall state the purpose of the meeting and the time and place where it is to be held. If the developer fails to call a meeting within the time specified herein, the meeting may be called and notice given by any unit owner.

4. Developer Responsibility. If the owners, other than the Declarant, do not select members for the committee as provided hereinabove, the developer shall have no further responsibility to form the committee.

### ARTICLE III

#### TURNOVER MEETING

1. Time of Meeting. The developer shall call a turnover meeting within ninety (90) days of the expiration of the earlier of three years from the date of the conveyance of the first unit to a person other than the declarant or conveyance of seventy-five percent (75%) of the units.

2. Notice. The developer shall give notice of the turnover meeting in accordance with the Bylaws of the Association to each unit owner at least seven (7) but not more than fifty (50) days prior to the meeting. The notice shall state the purpose of the meeting and the time and place where it is to be held. If the turnover meeting is not called by the developer within the time specified, the meeting may be called and notice given by any unit owner or any first mortgagee of the unit.

3. Relinquishment of Control. At the turnover meeting, the developer shall relinquish control of the administration of the Association and the unit owners shall elect a Board of Directors in accordance with the Bylaws of the Association. At the turnover meeting the developer shall deliver to the association all items, articles and documents specified in ORS § 100.210.

4. Continuing Developer Responsibility. In order to facilitate an orderly transition, during the three-month period following the turnover meeting, the developer or an informed representative shall be available to meet with the Board of Directors on at least three mutually acceptable dates to review the documents delivered under Section 3 of this Article.

If the developer has complied with the provisions of these Bylaws, unless the developer otherwise has sufficient voting rights as a unit owner to control the Association, the developer shall not be responsible for the failure of the unit owners to comply with Section 3 of this Article and the developer shall be relieved of any further responsibility for the administration of the Association except as a unit owner of any unsold unit.

#### ARTICLE IV

##### MEETINGS OF ASSOCIATION

1. Place of Meetings. The Association shall hold meetings at such suitable place convenient to the unit owners as may be designated by the Board of Directors from time-to-time.

2. Annual Meetings. The annual meetings of the Association shall be held in the months of January or February at such hour and on such date as the Chairman may designate, or if the chairman should fail to designate such date by the first day of February, then on the last Tuesday in February. The annual meetings shall be for the purposes of electing directors and for the transaction of such other business as may properly come before the meeting.

3. Special Meetings. Special meetings of the Association may be called by the chairman or secretary or by a majority of the Board of Directors, and must be called by such officers upon receipt of a written request from at least thirty percent (30%) of the unit owners stating the purpose of the meeting. Business transacted at a special meeting shall be confined to the purposes stated in the notice.

4. Notice of Meetings. Notice of all meetings of the Association stating the time and place and the purpose for which the meeting is being called shall be given by the chairman or secretary. Such notice shall be in writing and mailed to each unit owner at his/her address as it appears on the books of the Association not less than ten (10) days nor more than fifty (50) days prior to the date of the meeting. Proof of such mailing shall be given by the affidavit of the person giving the notice. Notice of meeting may be waived by any unit owner before or after meetings. When a meeting is adjourned for less than thirty (30) days, no notice of the adjourned meeting need be given other than by announcement at the meeting at which such adjournment takes place.

5. Voting. Each unit owner shall be entitled to one vote in the affairs of the Association for each unit owned by him. The developer shall be entitled to vote as the unit owner of any then existing units retained by the developer, and the Board of

Directors shall be entitled to vote on behalf of any unit which has been acquired by or on behalf of the Association; provided, however, that the Board of Directors shall not be entitled to vote such units in any elections of directors.

6. Proxies. A vote may be cast in person or by proxy. A proxy given by a unit owner to any person who represents such owner at meetings of the Association shall be in writing, signed by such owner, and filed with the secretary. No proxy shall be valid after the meeting for which it was solicited, unless otherwise expressly stated in the proxy, and every proxy shall automatically cease upon sale of the unit by its owner. A unit owner may pledge or assign his/her voting rights to a mortgagee. In such a case, the mortgagee or its designated representative shall be entitled to receive all notices to which the unit owner is entitled hereunder and to exercise the unit owner's voting rights from and after the time that the mortgagee shall give written notice of such pledge or assignment to the Board of Directors.

7. Fiduciaries and Joint Owners. An executor, administrator, guardian or trustee may vote, in person or by proxy, at any meeting of the Association with respect to any unit owned or held by him in such capacity, whether or not the same shall have been transferred to his name; provided, that he shall satisfy the secretary that he is the executor, administrator, guardian or trustee, holding such unit in such capacity. Whenever any unit is owned by two or more persons jointly, according to the records of the Association, the vote of such unit may be exercised by any one of the owners then present, in the absence of protest by a co-owner. In the event of such protest, no one co-owner shall be entitled to vote without the approval of all co-owners. In the event of disagreement among the co-owners, the vote of such unit shall be disregarded completely in determining the proportions of votes given with respect to such matter.

8. Quorum of Unit Owners. At any meeting of the Association, fifty percent (50%) of the unit owners, computed as provided in Article I, Section 7(b), present in person or by proxy, shall constitute a quorum. The subsequent joinder of a unit owner in the action taken at a meeting by signing and concurring in the minutes thereof shall constitute the presence of such person for the purpose of determining a quorum. When a quorum is once present to organize a meeting, it cannot be broken by the subsequent withdrawal of a unit owner or owners. If any meeting of members cannot be organized because of a lack of quorum, the members who are present, either in person or by proxy, may adjourn the meeting from time-to-time until a quorum is present.

9. Majority Vote. The vote of more than fifty percent (50%) of the unit owners, computed as provided in Article I, Section 7(b), present in person or by proxy, at a meeting at which a quorum is constituted shall be binding upon all unit owners for all purposes except where a higher percentage vote is required by law, by the Declaration or by these Bylaws.

10. Order of Business. The order of business at annual meetings of the Association shall be:

- (a) Calling of the roll and certifying of proxies;
- (b) Proof of notice of meeting or waiver of notice;
- (c) Reading of minutes of preceding meeting;
- (d) Reports of officers;
- (e) Reports of committees, if any;
- (f) Election of directors;
- (g) Unfinished business;
- (h) New business; and,
- (i) Adjournment.

#### ARTICLE V

##### BOARD OF DIRECTORS

1. Number and Qualifications. The affairs of the Association shall be governed by a Board of Directors comprised of three (3) persons, as provided in Sections 2 and 3 of this Article. All directors, other than interim directors appointed by the developer, shall be owners or co-owners of units of the condominiums. For purposes of this section, the officers of any corporate owner and the partners of any partnership shall be considered co-owners of any units owned by such corporation or partnership.

2. Interim Directors. Upon the filing of the Declaration submitting the condominiums to the Oregon Condominium Act, the developer shall appoint an interim board of three (3) directors, who shall serve until replaced by the developer or their successors have been elected by the unit owners as hereinafter provided.

3. Election and Term of Office. At the turnover meeting after seventy-five (75%) of the units have been sold and conveyed to purchasers, the interim directors shall resign and three (3) successors shall be elected, two for two-year terms and one for a one-year term. Thereafter, at the expiration of the initial term of office of each director, his/her successor shall be elected to serve for a term of two years so that the term of no less than one-third of the directors shall expire annually. Directors shall hold office until their respective successors have been elected by the unit owners. Election shall be by plurality.

4. Vacancies. Vacancies in the Board of Directors caused by any reason other than the removal of a director by a vote of the Association shall be filled by vote of the majority of the remaining directors, even though they may constitute less than a quorum, or by a sole remaining director. Each person so elected to fill the unexpired term shall be confirmed at the next annual meeting of the Association or the next special meeting of the Association called for that purpose. Vacancies of interim directors, however, shall be filled by the developer.

5. Removal of Directors. At any regular or special meeting of the Association duly called, any one or more of the directors, other than interim directors, may be removed with or without cause by a majority vote of the unit owners present in person or by proxy, and a successor shall be elected at that meeting to fill the vacancy thus created. The notice of any such meeting shall state that such removal is to be considered and any director whose removal has been proposed shall be given an opportunity to be heard at the meeting.

6. Powers and Duties. The Board of Directors shall have all of the powers and duties necessary for the administration of the affairs of the Association, except such powers and duties as by law or by the Declaration or by these Bylaws may not be delegated to the Board of Directors by the unit owners. The powers and duties to be exercised by the Board of Directors shall include, but shall not be limited to the following:

(a) Operation, care, upkeep, maintenance and repair of the general and limited common elements.

(b) Determination of the amounts required for the operation, maintenance and other affairs of the Association and the making of such expenditures.

(c) Collection of the common expenses from the unit owners.

(d) Employment and dismissal of such personnel as secretary for the efficient maintenance, upkeep and repair of the common elements.

(e) Employment of legal, accounting or other personnel for reasonable compensation to perform such services as may be required for the proper administration of the Association and for the preparation of any required tax returns.

(f) Opening of bank accounts on behalf of the Association and designating the signatories required therefor.

(g) Purchasing units of the condominium project at foreclosure or other judicial sales in the name of the Association, or its designee, on behalf of all the unit owners as provided in these Bylaws.

(h) Selling, leasing, mortgaging, voting the votes appurtenant to (other than for the election of directors), or otherwise dealing with units of the condominium acquired by the Association or its designee on behalf of all the unit owners.

(i) Obtaining insurance or bonds pursuant to the provisions of these Bylaws.

(j) Making additions and improvements to, or alterations of, the common elements; provided, however, that no such project may be undertaken by the board if the total cost will exceed the amount of five hundred dollars (\$500.00), unless the unit owners have enacted a resolution authorizing the project by a vote of seventy-five percent (75%) of the unit owners present in person or by proxy at a meeting at which a quorum is constituted. This limitation shall not be applicable to repairs or maintenance undertaken pursuant to paragraph (a) above.

(k) Enforcement by legal means of the provisions of the Oregon Condominium Act, the Declaration filed thereunder, these Bylaws and any rules and regulations adopted hereunder.

(l) Filing with the Real Estate Agency an annual report and any amendment thereto in accordance with ORS Sections 100.250 and 100.260.

7. Managing Agent or Manager. On behalf of the Association, the Board of Directors may employ or contract for a managing agent or a manager at a compensation to be established by the Board of Directors. The Board of Directors may delegate to the managing agent or manager such duties and powers as the Board of Directors may authorize. In the absence of such appointment, the Board of Directors shall act as manager.

8. Organizational Meetings. Within fourteen (14) days following the annual meeting of the Association or following any meeting at which an election of directors has been held, the Board of Directors shall hold an organizational meeting at such place and time as shall have been fixed by the directors at the meeting at which the election was held.

9. Regular and Special Meetings. Regular meetings of the Board of Directors may be held at such time and place as shall be determined from time-to-time by a majority of the directors. Special meetings of the Board of Directors may be called by the chairman and must be called by the secretary at the written request of at least two directors. Notice of any special meeting shall be given to each director, personally or by mail, telephone or telegraph at least seven (7) days prior to the day named for such meeting and shall state the time, place and purpose of such meeting. Any unit owner may attend a Board meeting.

10. Waiver of Notice. Any director may, at any time, waive notice of any meeting of the Board of Directors in writing, and such waiver shall be deemed equivalent to the giving of such notice. Attendance by a director at any meeting of the Board shall constitute a waiver by him/her of notice of the time and place thereof, except where a director attends the meeting for the express purpose of objecting to the transaction of any business because the meeting is not lawfully called or convened. If all of the directors are present at any meeting of the Board, no notice shall be required and any business may be transacted at such meeting.

11. Quorum of Board of Directors. At all meetings of the Board of Directors, a majority of the directors shall constitute a quorum for the transaction of business, and the votes of a majority of the directors present at a meeting at which a quorum is present shall constitute the decision of the directors. If less than a quorum should be present, a majority of those present may adjourn the meeting from time-to-time. At any such adjourned meeting at which a quorum is present, any business which might have been transacted at the meeting originally called may be transacted without further notice.

12. Compensation. No director shall receive any compensation from the Association for acting as such.

13. Liability and Indemnification of Directors, Officers, Manager or Managing Agent. The directors and officers shall not be liable to the Association of the unit owners for any mistake of judgment, negligence, or otherwise, except for their own willful misconduct or bad faith. The Association shall indemnify and hold harmless each director and officer and the manager or managing agent, if any, against all contractual liability to



others arising out of contracts made by the Board of Directors, officers, manager or managing agent on behalf of the Association, unless any such contract shall have been made in bad faith or contrary to the provisions of the Declaration or of these Bylaws. Each director and officer and the manager or managing agent, if any, shall be indemnified by the Association against all expenses and liabilities, including attorney's fees reasonably incurred or imposed upon them in connection with any proceeding to which they may be a party, or, in which they may become involved, by reasons of being or having been a director, officer, manager or managing agent, and shall be indemnified upon any reasonable settlement thereof; provided, however, there shall be no indemnity if the director, officer, manager or managing agent is adjudged guilty of willful nonfeasance, misfeasance or malfeasance in the performance of his duties.

14. Fidelity Bonds. The Board of Directors may require that any person or entity, including, but not limited to, employees of any professional manager, who handles or is responsible for Association funds shall furnish such fidelity bond as the Board deems adequate. The premiums on such bonds may be paid by the Association.

15. Insurance. The Board of Directors shall obtain the insurance required in Article VIII of these Bylaws. In addition, the Board of Directors, in its discretion, may obtain such other insurance as it deems necessary to protect the interests of the Association of unit owners. The Board of Directors shall conduct an annual insurance review which, if appropriate, shall include an appraisal of all improvements contained in the condominiums.

#### ARTICLE VI

##### OFFICERS

1. Designation. The principal officers of the Association shall be the chairman, the secretary and the treasurer, all of whom shall be elected by the Board of Directors. The position of secretary and treasurer may be held by one person. The directors may appoint such other officers as in their judgment may be necessary. The chairman shall be a member of the Board of Directors, but other officers need not be directors or unit owners.

2. Election of Officers. The officers of the Association shall be elected annually by the Board of Directors at the organizational meeting of each new Board and shall hold office at the pleasure of the Board. If any office shall become vacant, the Board of Directors shall elect a successor to fill the unexpired term at any regular meeting of the Board of Directors,

or at any special meeting of the Board of Directors called for such purpose.

3. Removal of Officers. Upon the affirmative vote of a majority of the directors, any officer may be removed either with or without cause, and his successor may be elected at any regular meeting of the Board of Directors, or at any special meeting of the Board of Directors called for such purpose.

4. Chairman. The chairman shall be the chief executive officer of the Association. He/she shall preside at all meetings of the Association and of the Board of Directors. He/she shall have all of the general powers and duties which are usually vested in the chief executive officer of an association, including, but not limited to, the power to appoint committees from among the unit owners from time-to-time as he may in his discretion decide is appropriate to assist in the conduct of the affairs of the Association.

5. Secretary. The secretary shall keep the minutes of all proceedings of the Board of Directors and the minutes of all meetings of the Association. He/she shall attend to the giving and serving of all notices to the unit owners and directors and other notices required by law. He/she shall keep the records of the Association, except for those of the treasurer, and shall perform all other duties incident to the office of secretary of an association and as may be required by the directors or the chairman. In addition, the secretary shall act as vice-chairman, taking the place of the chairman and performing his/her duties whenever the chairman is absent or unable to act, unless the directors have appointed another vice-chairman.

6. Treasurer. He/she shall have the responsibility for Association funds and securities and shall be responsible for keeping full and accurate financial records and books of account showing all receipts and disbursements and for the preparation of required financial statements. He/she shall be responsible for the deposit of all monies and other valuable effects in such depositories as may from time-to-time be designated by the Board of Directors, and he/she shall disburse funds of the Association upon properly authorized vouchers.

7. Execution of Instruments. All agreements, contracts, deeds, leases and other instruments of the Association, except checks, shall be executed by such person or persons as may be designated by general or special resolution of the Board of Directors and in the absence of any general or special resolution applicable to any such instrument, then such instrument shall be signed by the chairman. All checks shall be signed by the treasurer, or in his absence or disability, by the chairman.

8. Compensation of Officers. No officer who is a member of the Board of Directors, other than the secretary/treasurer, shall receive any compensation from the Association for acting as an officer, unless such compensation is authorized by a resolution duly adopted by the unit owners. The Board of Directors may fix any compensation to be paid to the secretary/treasurer or any officers who are not also directors.

## ARTICLE VII

### BUDGET, EXPENSES AND ASSESSMENTS

1. Budget. The Board of Directors shall from time-to-time, and at least annually, prepare a budget for the Association, estimate the common expenses expected to be incurred, less any previous overassessment, and assess the common expenses to each unit owner in the same proportion as his percentage interest in the common elements, except that legal/accounting, garbage and common element maintenance will be charged equally to units. Original purchasers of units will be required to pay \$100.00 each as a reserve toward expenses. The Board of Directors shall advise each unit owner in writing of the amount of common expenses payable by him/her, and furnish copies of each budget on which such common expenses are based to all unit owners and, if requested, to their mortgagees. In addition, original purchasers will be required to pay an additional \$100.00 into the reserve trust account established by Declarant pursuant to paragraph 4(b) of Article VII of these Bylaws.

2. Determination of Common Expenses. Common element expenses shall include:

- (a) Expenses of Administration.
- (b) Expenses of maintenance, repair or replacement of common elements.
- (c) Cost of insurance or bonds obtained in accordance with these Bylaws.
- (d) A general operating reserve.
- (e) Reserve for replacements and deferred maintenance.
- (f) Any deficit in common expenses for any prior period.
- (g) Utilities for the common areas and other utilities with a common meter or commonly billed, such as water, sewer and gas.

(h) Any other items properly chargeable as a common expense of the Association.

3. Assessment of Common Expenses. All unit owners shall be obliged to pay common expenses assessed to them by the Board of Directors on behalf of the Association pursuant to these Bylaws and the Declaration. Assessments may not be waived due to limited or nonuse of common elements. The developer shall be assessed as the unit owner of any unsold unit, but such assessment shall be prorated to the date of sale of the unit as assessments for reserves need not be paid until closing of such sale. The Board of Directors, on behalf of the Association, shall assess the common expenses against the unit owners from time-to-time, and at least annually, and shall take prompt action to collect from a unit owner any common expense due which remains unpaid by him for more than thirty (30) days from the due date for its payment.

4. Special Assessments.

(a) Capital Improvements. In the case of any duly authorized capital improvement to the common elements, the Board of Directors may, by resolution, establish separate assessments for the same, which may be treated as capital contributions by the unit owners and the proceeds of which shall be used only for the specific capital improvements described in the resolution.

(b) Reserve Trust Funds. In establishing reserves for the replacement of the common elements, the Declarant has established at least one trust fund and the Board of Directors may elect by resolution to establish one or more trust funds for the replacement of specific items which normally will require replacement in more than three years and in not less than thirty years, in which case the Board shall either designate part of the regular assessment or establish separate assessments for such purposes. The proceeds therefrom shall be held in such trust funds and used only for the designated replacements. Pursuant to ORS 100.175(7), future assessments for the reserve account may be reduced, eliminated or increased by an affirmative vote of not less than seventy five (75%) of all voting rights, following the second year after the unit owners have assumed administrative responsibility for the association under ORS 100.210.

5. Default in Payment of Common Expenses. In the event of default by any unit owner in paying to the Association the assessed common expenses, such unit owner shall be obligated to pay interest at the rate of ten percent (10%) per annum on such common expenses from the due date thereof, together with all expenses, including attorney's fees incurred by the Association in any proceeding brought to collect such unpaid expenses or any appeal therefrom. The Board of Directors shall have the right

and duty to recover for the Association such common expenses, together with interest thereon, and expenses of the proceeding, including attorneys' fees, by an action brought against such unit owner or by foreclosure of the lien upon the unit granted by the Oregon Condominium Act. The Board of Directors shall notify the holder of any first mortgage upon a unit of any default not cured within sixty (60) days of the date of default.

6. Foreclosure of Liens for Unpaid Common Expenses. In any suit brought by the Association to foreclose a lien on a unit because of unpaid common expenses, the unit owner shall be required to pay a reasonable rental for the use of the unit during the pendency of the suit and the plaintiff in such foreclosure suit shall be entitled to the appointment of a receiver to collect such rental. The Board of Directors, acting on behalf of the Association, shall have the power to purchase such unit at the foreclosure sale and to acquire, hold, lease, mortgage, vote the votes appurtenant to, convey, or otherwise deal with the unit. An action to recover a money judgment for unpaid common expenses shall be maintainable without foreclosing the liens securing the same.

7. First Mortgages. Where the purchaser or mortgagee of a unit obtains title to the unit as a result of foreclosure of a first mortgage or by deed in lieu of foreclosure, such purchaser or mortgagee, his/her successors and assigns, shall not be liable for any of the common expenses chargeable to such unit which became due prior to the acquisition of title to such unit by such purchaser or mortgagee. Such unpaid share of common expenses, to the extent uncollectible from the foreclosed owner(s), shall be a common expense and reallocated on a pro rata basis to all units, including the mortgaged unit.

#### ARTICLE VIII

##### RECORDS AND AUDITS

1. General Records. The Board of Directors and the managing agent or manager, if any, shall keep detailed records of the actions of the Board of Directors and the managing agent or manager, minutes of the meetings of the Board of Directors and minutes of the meetings of the Association. The Board of Directors shall maintain a list of owners entitled to vote at meetings of the Association and a list of all mortgagees of units.

2. Records of Receipts and Expenditures. The Board of Directors or its designee shall keep detailed, accurate records in chronological order of the receipts and expenditures affecting the common elements, itemizing the maintenance and repair expenses of the common elements and any other expenses incurred.

Such records and the vouchers authorizing the payments shall be available for examination by the unit owners and mortgagees at convenient hours of weekdays.

3. Assessment Roll. The assessment roll shall be maintained in a set of accounting books in which there shall be an account for each unit. Such account shall designate the name and address of the owner or owners, the amount of each assessment against the owners, the dates and amounts in which the assessment comes due, the amounts paid upon the account and the balance due on the assessments.

4. Payment of Vouchers. The secretary/treasurer shall pay all vouchers up to five hundred dollars (\$500) signed by the chairman, managing agent, manager or other person authorized by the Board of Directors. Any voucher in excess of five hundred dollars (\$500) shall require the signature of the chairman.

5. Reports and Audits. A brief annual statement of the receipts and expenditures of the Association shall be rendered by the Board of Directors to all unit owners and to all mortgagees of units who have requested the same within thirty (30) days after the end of each fiscal year in compliance with ORS § 100.480. From time-to-time the Board of Directors, at the expense of the Association, may obtain an audit of the books and records pertaining to the Association and furnish copies thereof to the owners and such mortgagees. At any time any owner or mortgagee may, at his own expense, cause an audit or inspection to be made of the books and records of the Association.

6. Notice of Sale, Mortgage, Rental or Lease. Immediately upon the sale, mortgage, rental or lease of any unit, the unit owner shall promptly inform the secretary or manager of the name and address of said vendee, mortgagee, lessee or tenant.

#### ARTICLE IX

##### MAINTENANCE AND USE OF CONDOMINIUM PROPERTY

1. Maintenance and Repair. Except as otherwise provided herein for damage or destruction caused by casualty:

(a) Units. All maintenance of said repairs to any unit shall be made by the owner of such unit, who shall keep the same in good order, condition and repair and shall do all redecorating, painting and staining which at any time may be necessary to maintain the good appearance and condition of the unit. In addition, each unit owner shall be responsible for the maintenance, repair, or replacement of windows and doors and any plumbing, heating or air conditioning fixtures, telephones, water

heaters, fans, lighting or other appliances and accessories that may be in or connected with the unit.

(b) Common Elements. All maintenance, repairs and replacements to the general and limited common elements shall be made by the Association and shall be charged to the unit owners as provided in the Declaration. Each unit owner, however, shall keep the limited common elements which pertain to his/her unit in a neat, clean and sanitary condition.

2. Additions, Alterations or Improvements. A unit owner shall not, without first obtaining written consent of the Board of Directors, make, or permit to be made, any structural alteration, improvement, or addition in or to his/her unit, or in or to the exterior of the buildings or any other general or limited common elements. A unit owner shall make no repair or alteration or perform any other work on his/her unit which would jeopardize the soundness or safety of the property, or reduce the value thereof or impair any easement or hereditament unless the written consent of all unit owners affected is obtained. A unit owner shall not paint or decorate any portion of the exterior of the buildings or other general or limited common elements without first obtaining written consent of the Board of Directors.

3. Damage or Destruction by Casualty of Condominium Property.

(a) In the event of damage or destruction by casualty of condominium property, the damage or destruction shall be repaired, reconstructed or rebuilt unless, within fourteen (14) days of such damage or destruction, the Board of Directors or more than ten percent (10%) of the unit owners shall have requested a special meeting of the Association. Such special meeting must be held within sixty (60) days of the date of damage or destruction. At the time of such meeting, unless ninety percent (90%) of the unit owners, whether in person, by writing or by proxy, vote not to repair, reconstruct or rebuild the damaged property, the damage or destruction shall be repaired, reconstructed or rebuilt. In the case of substantial damage or destruction, timely written notice thereof shall be given to the unit owners and their mortgagees.

(b) The Association shall be responsible for repairing, reconstructing or rebuilding all such damage or destruction to the common elements and, to the extent of the Association's insurance coverage, all such damage or destruction to the units. Each unit owner shall be responsible for such repairing, reconstructing or rebuilding of his/her unit as is not covered by the Association's insurance.

(c) If, due to the act of neglect of a unit owner or of a member of his family or his household pet or of a guest or other authorized occupant or visitor of such unit owner, damage shall be caused to the common elements or to a unit owned by others, or maintenance, repairs or replacements shall be required which would otherwise be a common expense, such unit owner shall pay for such damage and such maintenance, repairs and replacements as may be determined by the Association, to the extent not covered by the Association's insurance.

(d) In the event the insurance proceeds paid to the Association are not used to repair, reconstruct or rebuild the damaged or destroyed property, the Association shall distribute the proceeds among the unit owners and their mortgagees (as their interests may appear) in the same proportion as their respective interest in the general common elements.

4. Condemnation. In the event of a taking in condemnation by eminent domain of part or all of the common elements, the award made for such taking shall be payable to the Association. If such proceedings are instituted or such acquisition is sought by a condemning authority as to any portion of the property, prompt notice thereof shall be given to the unit owners and their mortgagees. If seventy-five percent (75%) or more of the unit owners duly and promptly approve the repair or restoration of such common elements, the Board of Directors shall arrange for the same, which shall be paid out of the proceeds of the award. In the event seventy-five percent (75%) or more of the unit owners do not duly and promptly approve the repair and restoration of such common elements, the Board of Directors shall disburse the net proceeds of such award to the unit owners and their mortgagees (as their interests may appear) in the same proportions as the respective undivided interests of the unit owners in the general common elements.

5. Restrictions and Requirements Respecting Use of Condominium Property. The following restrictions and requirements are in addition to all other restrictions and requirements contained in the Declaration and these Bylaws:

(a) Residential Use. No commercial activities of any kind shall be carried on in any unit or in any other portion of the condominium without the consent of the Board or the Association or the managing agent, except activities relating to the rental or sale of units. This provision, however, shall not be construed so as to prevent or prohibit a unit owner from maintaining his/her professional or personal library, keeping his/her personal business or professional records or accounts, handling his/her personal business or professional telephone calls, or conferring with



business or professional associates, clients or customers, in his/her unit.

(b) Use of Common Elements. The common elements shall be used for the furnishing of services and facilities for which the same are reasonably intended for the enjoyment of the units. The use, operation and maintenance of the common elements shall not be obstructed, damaged or unreasonably interfered with by any unit owner.

(c) Offensive or Unlawful Activities. No noxious or offensive activities shall be carried on in any unit nor shall anything be done or placed upon any unit which interferes with or jeopardizes the enjoyment of other units or the common elements or which is a source of annoyance to residents. Unit occupants shall exercise extreme care not to make noises which may disturb other unit occupants, including the use of musical instruments, radios, televisions and amplifiers. No unlawful use shall be made of the condominium nor any part thereof, and all valid laws, zoning ordinances, and regulations of all governmental bodies having jurisdiction thereof shall be observed.

(d) Animals. No animals or fowls shall be raised, kept or permitted within the condominiums or any part thereof, except domestic dogs, cats or other household pets kept within a unit. No such dogs, cats or pets shall be permitted to run at large nor shall be kept, bred or raised for commercial purposes or in unreasonable numbers. Any inconvenience, damage or unpleasantness caused by such pets shall be the responsibility of the respective owners thereof. All dogs shall be kept on a leash while outside a unit. A unit owner may be required to remove a pet after receipt of two notices in writing from the Board of Directors of violations of any rules, regulations or restrictions governing pets within the condominium.

(e) Exterior Lighting or Noisemaking Devices. Except with the consent of the Board of Directors of the Association or the managing agent, no exterior lighting or noisemaking devices shall be installed or maintained on any unit and no antenna nor transmitting towers shall be affixed to the general or limited common elements.

(f) Windows, Balconies and Outside Walls. In order to preserve the attractive appearance of the condominiums, the Board of Directors of the Association

or the managing agent may regulate the nature of items which may be placed in or on windows, balconies, decks, porches, entryways, any carports and the outside walls so as to be visible from other units, the common elements, or outside the condominiums. Garments, rugs, laundry and other similar items may not be hung from windows or facades.

(g) Trailers, Campers and Boats. Except with the consent of the Board of Directors of the Association or the managing agent, no trailer, truck, camper, boat or boat trailer, or other recreational vehicle shall be parked on any portion of the condominium property.

(h) Leasing and Rental of Units. Except with the consent of the Board of Directors of the Association or the managing agent, no unit owner may lease or rent less than his entire unit, and no such owner may rent his/her unit for transient or motel purposes. All such leases or rentals shall provide that the terms of the lease shall be subject in all respects to the provisions of the Declaration and these Bylaws and that any failure by the lessee or tenant to comply with the terms of such documents shall be a default under the lease. Other than the foregoing, there is no restriction on the right of any unit owner to lease or rent his unit.

(i) Signs. Unless written approval is first obtained from the Board of Directors, no sign of any kind shall be displayed to the public view on or from any such unit or the common elements except signs used by the developer to advertise units for sale or lease.

(j) Trash. No part of any unit or any part of the common elements shall be used or maintained as a dumping ground for rubbish, trash, garbage or other waste. No garbage, trash or other waste shall be kept or maintained on any part of the property except in sanitary containers in the designated areas.

(k) Association Rules and Regulations. In addition, the Board of Directors from time-to-time may adopt, modify, or revoke such rules and regulations governing the conduct of persons and the operation and use of the units and common elements as it may deem necessary or appropriate in order to assure the peaceful and orderly use and enjoyment of the condominium property. However, the Board of Directors cannot adopt any rule or regulation banning the keeping of pets or residency by children. Any modification of

the rules or regulations by the Board may itself be modified by vote of not less than seventy-five percent (75%) of the unit owners present, in person or by proxy at any meeting, the notice of which shall have stated that such modification or revocation of rules and regulations will be under consideration. A copy of the rules and regulations, upon adoption, and a copy of each amendment, modification or revocation thereof, shall be delivered by the secretary/treasurer promptly to each unit owner and shall be binding upon all unit owners and occupants of all units from the date of delivery.

(1) Insurance. Nothing shall be done or kept in any such unit or in the common elements which will increase the cost of insurance of the common elements. No owner shall permit anything to be done or kept in his/her unit or in the common elements which will result in cancellation of insurance on any unit or any part of the common elements.

6. Right of Entry. A unit owner shall grant the right of entry to the Board of Directors, managing agent, manager or any other person authorized by the Board of Directors in the case of any emergency originating in or threatening his unit or other condominium property, whether or not the owner is present at the time. A unit owner shall also permit such persons to enter his/her unit for the purpose of performing installation, alterations or repairs to any common element and for the purpose of inspection to verify that the unit owner is complying with the restrictions and requirements described in Section 5 of this Article, provided that requests for entry are made in advance and that such entry is at a time convenient to the owner. The owner of any unit adjoining an outside fire escape shall permit access through his/her unit to the fire escape in the case of any emergency. Any damage caused to the unit in order to obtain such emergency access, to the extent not covered by insurance, shall be the responsibility of the person seeking access.

7. Easements and Developer. The developer and its agents, successors and assigns shall have an easement over and upon the common elements for the purpose of constructing additional phases, making repairs to existing structures and carrying out sales and rental activities necessary or convenient for the sale or rental of units owned by the developer as model units and the right to use a unit as a sales office.

8. Abatement and Enjoining of Violations. The violation of any rule or regulation adopted hereunder or the breach of any Bylaw contained herein or of any provision of the Declaration shall give the Board of Directors, acting on behalf of the

Association, the right, in addition to any other rights set forth in these Bylaws:

(a) to enter the unit in which, or as to which, such violation exists and to summarily abate and remove, at the expense of the defaulting unit owner, any structure, thing, or condition that may exist there contrary to the intent and meaning of the provisions hereof, and the Board of Directors shall not thereby be deemed guilty of any manner of trespass; or,

(b) to enjoin, abate, or remedy such thing or condition by appropriate legal proceedings.

#### ARTICLE X

##### INSURANCE

1. Insurance. For the benefit of the Association and the unit owners, the Board of Directors shall obtain and maintain at all times and shall pay for out of the common expense funds the following insurance:

(a) A policy or policies of insurance covering loss or damage from fire with extended coverage endorsement and such other coverages such as flooding, which the Association may deem desirable, for not less than the full insurable replacement value of the units and common elements. Such policy or policies shall name the developer, the Association and the unit owners as insureds, as their interest may appear, and shall provide for a separate loss payable endorsement in favor of the mortgagee or mortgagees of each unit, if any. In no event shall the policy or policies have a deductible clause in excess of one thousand dollars (\$1,000) per unit.

(b) A policy or policies insuring the developer, the Association, the Board of Directors, the unit owners and the managing agent, against liability to the public or to the owners of units and of common elements, and their invitees or tenants, incident to the ownership or use of the property. There

may be excluded from such policy or policies coverage of a unit owner (other than as a member of the Association or Board of directors) for liability arising out of acts or omissions of such unit owner and liability incident to the ownership and/or use of the part of the property as to which such unit owner has the exclusive use of occupancy. Limits of liability under such insurance shall not be less than One Million Dollars (\$1,000,000) on a combined single limit basis. Such policy or policies shall be issued on a comprehensive liability basis and shall provide a cross-liability endorsement wherein the rights of named insureds under the policy or policies shall not be prejudiced respect to his, her or their action against another named insured; and,

(c) Workman's Compensation insurance to the extent necessary to comply with any applicable laws.

Each unit owner shall be responsible for obtaining, at his/her own expense, insurance covering his/her property not insured under paragraph (a) above and covering his/her liability not covered under paragraph (b) above, unless the Association agrees otherwise.

2. Policies. Insurance obtained by the Association shall be governed by the following provisions:

(a) All policies shall be written with the State of Oregon or a company licensed to do business in the State of Oregon and holding a policyholder's rating of "A" or better, and a financial size rating of at least class 10 or better by the Best's Insurance Reports current at the time the insurance is written or prior to the initial meeting of the Association, with a company acceptable to the developer.

(b) All losses under policies hereafter in force regarding the property shall be settled exclusively with the Board of Directors or its authorized representative. Proceeds of the policies shall be paid to the Association as trustee for the unit owners, or upon demand of any mortgagee, to an insurance

trustee acceptable to the Association and mortgagees of units.

(c) Each unit owner shall be required to notify the board of directors of all improvements made by the owner to his/her unit, the value of which is in excess of five hundred dollars (\$500.00). Nothing in this paragraph shall permit an owner to make improvements without first obtaining the approval of the Board of Directors pursuant to Article VII, Section 2.

(d) Any unit owner who obtains individual insurance policies covering any portion of the property other than his personal property and fixtures shall file a copy of such individual policy or policies with the Association within thirty (30) days after the purchase of such insurance.

3. Provisions. The Board of Directors shall make every effort to secure insurance policies that will provide for the following:

(a) A waiver of subrogation by the insurer as to any claim against the Board of Directors, the managing agent, the unit owners and their respective servants, agents and guests.

(b) A provision that the master policy on the condominium cannot be canceled, invalidated or suspended on account of the conduct of any one or more individual owners.

(c) A provision that the master policy on the condominium cannot be canceled, invalidated or suspended on account of the conduct of any officer or employee of the Board of Directors or the managing agent without prior demand in writing that the Board of Directors or managing agent cure the defect.

(d) A provision that any "no other insurance" clause in the master policy exclude individual owners' policies from consideration, and a waiver of the usual proration with respect to such policies.

(e) A provision that the insurer issue subpolicies specifying the portion of the master policy earmarked for each owner's interest and that until the insurer-furnished written notice and a grace period to the mortgagee insured under the loss-payable clause thereof, the mortgagee's coverage is neither jeopardized by the conduct of the unit mortgager-owner, the Association, or other unit owners not canceled for nonpayment of premiums.

(f) A rider on the master policy patterned after "Use and Occupancy" insurance which will provide relief from monthly assessments while a unit is uninhabitable by the payment of the condominium expenses thereof and any other fixed costs, including, but without being limited to, taxes, rent, insurance, and mortgage payments. The proceeds from any casualty policy, whether held by the Association or a unit owner, payable with respect to any loss or damage to the common elements, shall be held in trust for the benefit of all insureds as their interest may appear.

(g) A waiver of the insurer's right to determine whether the damage should be repaired. If reasonably available, the policy or policies should contain a stipulated amount clause, or determinable cash adjustment clause, or similar clause to permit a cash settlement covering specified value in the event of destruction and a decision not to rebuild.

#### ARTICLE XI

##### AMENDMENTS TO BYLAWS

1. Now Proposed. Amendments to the Bylaws shall be proposed by either a majority of the Board of Directors or by thirty percent (30%) of the unit owners. The proposed amendment must be reduced to writing and shall be included in the notice of any meeting at which action is to be taken thereon.

2. Adoption. A resolution adopting a proposed amendment may be proposed by either the Board of Directors or by the unit owners and may be approved by the unit owners at a meeting called for this purpose or at a regular annual meeting. Unit owners not

present at the meeting considering such amendment may express their approval in writing or by proxy. Any resolution must be approved by a majority of the unit owners except for amendments relating to age restrictions, pet restrictions, limitations on the number of persons who may occupy units and limitations on the rental or leasing of units which must be approved by seventy-five percent (75%) of the unit owners. If required under the Oregon Condominium Act, any amended Bylaws or amendment to a Bylaw shall be approved by the Real Estate Commissioner before it is recorded. Neither Article V, Section 8, nor any other provision of these Bylaws which is for the benefit of mortgagees may be amended without the written consent of all mortgagees.

3. Execution and Recording. An amendment shall not be effective until certified by the chairman and secretary of the Association, approved by the Real Estate Commissioner and recorded as required by law.

## ARTICLE XII

### MISCELLANEOUS

1. Notices. All notices to the Association or to the Board of Directors shall be sent care of the managing agent or, if there is no managing agent, to the principal office of the Association or to such other address as the Board of Directors may hereafter designate from time-to-time. All notices to any unit owner shall be sent to such address as may have been designated by him from time-to-time, in writing, to the Board of Directors or if no address has been designated, then to the owner's unit.

2. Waiver. No restriction, condition, obligation, or provision contained in these Bylaws shall be deemed to have been abrogated or waived by reason of any failure to enforce the same, irrespective of the number of violations or breaches thereof which may occur.

3. Invalidity; Number; Captions. The invalidity of any part of these Bylaws shall not impair or affect in any manner the validity, enforceability or effect of the balance of these Bylaws. As used herein, the singular shall include the plural, and the plural the singular. The masculine and neuter shall each include the masculine, feminine and neuter, as the context required. All captions used herein are intended solely for convenience of reference and shall in no way limit any of the provisions of these Bylaws.

4. Action Without a Meeting. Any action which the Oregon Condominium Act, the Declaration or the Bylaws require or permit



the owners or directors to take at a meeting may be taken without a meeting if a consent in writing setting forth the action so taken is signed by all of the owners or directors entitled to vote on the matter. The consent, which shall have the same effect as a unanimous vote of the owners or directors, shall be filed in the records of minutes of the Association.

5. Conflicts. These Bylaws are intended to comply with the Oregon Condominium Act and the Declaration. In case of any irreconcilable conflict, such statute and document shall control over these Bylaws or any rules and regulations adopted hereunder.

DATED, at Portland, Oregon, this 21 day of August, 1995.

Adopted by Kings Hill Project, L.L.C.,  
an Oregon Limited Liability Company  
by Port West Properties, Inc., its Managing Agent.

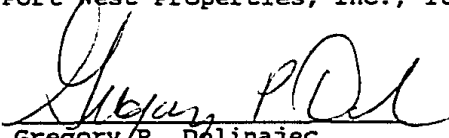
By:   
Gregory P. Dolinajec  
President

KHBYLAWS

STATE OF OREGON }  
Multnomah County } 41  
I, a Deputy for the Recorder of Conveyances in and for  
said County, do hereby certify that the within instrument of  
writing was received for record and recorded in the record  
of said County.  
95 SEP 27 PM 2:37  
RECORDING SECTION  
MULTNOMAH CO., OREGON  
95 118110  
Witness my hand and seal of office at said  
Recorder of Conveyances  
C Swick  
Deputy

KINGS HILL CONDOMINIUMS  
BYLAWS MAY 24, 1995

26

26

130  
13

RETURN TO  
FIDELITY NATIONAL  
401 SW 4TH AVE  
PORTLAND, OR 97204  
ATTN: LAND DEVELOPMENT

DECLARATION  
SUBMITTING  
KINGS HILL CONDOMINIUMS  
TO CONDOMINIUM OWNERSHIP

Filed by:  
KINGS HILL PROJECT, L.L.C.,  
AN OREGON CORPORATION LIMITED LIABILITY COMPANY

THIS DECLARATION, pursuant to the provisions of the Oregon Condominium Act, is made and executed as hereinafter set forth by KINGS HILL PROJECT, L.L.C., AN OREGON LIMITED LIABILITY COMPANY, hereinafter called "Declarant".

Declarant proposes to create condominiums to be known as Kings Hill Condominiums, which will be located in the City of Portland, Multnomah County, Oregon. The purpose of this Declaration is to submit Kings Hill Condominiums to the condominium form of ownership and use in the manner provided by the Oregon Condominium Act. The condominiums will be used for residential purposes.

NOW, THEREFORE, Declarant does hereby declare and provide as follows:

1. DEFINITIONS. When used herein the following terms shall have the following meanings:

1.1 "Bylaws" means the Bylaws of the Association of Unit Owners of Kings Hill Condominiums adopted pursuant to Section 12 below and, as the same, may be amended from time-to-time.

1.2 "Declarant" means KINGS HILL PROJECT, L.L.C., AN OREGON LIABILITY COMPANY, and its successors and assigns.

1.3 "Plans" means the plat or site plan and floor plans of Kings Hill Condominiums recorded simultaneously with this Declaration.

1.4 "Incorporation by Reference". Except as otherwise provided in this Declaration, each of the terms defined in ORS 100.005, a part of the Oregon Condominium Act, shall have the meanings set forth in such section.

KINGS HILL CONDOMINIUMS DECLARATION  
MAY 24, 1995

1049

95 118109

2. PROPERTY SUBMITTED. The property submitted to the Oregon Condominium Act hereunder is a project undertaken by Declarant and the fee owners under which the fee owners affirm all documentation prepared by Declarant and required in the condominium filing process herein.

The land submitted hereunder is located in the City of Portland, Multnomah County, Oregon, and is more particularly described in Exhibit A hereto. Such property includes the land so described, all buildings, improvements and structures thereon, all easements, rights and appurtenances belonging thereto, and all personal property used in connection therewith.

3. Name. The name by which the property submitted hereunder shall be known is "Kings Hill Condominiums".

4. Units.

4.1 General Description of Building. Kings Hill Condominiums is a four story, U-shaped, brick and concrete with a composition roof, elevator-served apartment building built in 1907. There are 18 units; 1 studio, 9 one-bedroom, 6 two-bedroom and 2 three-bedroom units. There is also a ground floor furnace room.

4.2 General Description, Location and Designation of Units. The condominiums consist of a total of eighteen (18) units. The average area of the units is 1040 square feet. Each unit has a kitchen, living room, bedroom, bathroom. The floors are hardwood surfaced and the walls and ceilings are covered by "popcorn-style" acoustic or painted plaster. The dimensions, designation and location of each unit are shown in the plans recorded simultaneously herewith. A general description and the approximate square footage of each unit is shown on Exhibit B attached hereto.

4.3 Boundaries of Units. Each unit shall be bounded by the interior surfaces of its perimeter and bearing walls, floors, ceilings, windows and window frames, door and door frames, and trim, and shall include both the interior surfaces so described and the air space so encompassed. In addition, each unit shall include the outlet of any utility service lines, including water, sewerage, gas or electricity, and ventilating ducts, within the unit, but shall not include any part of such lines or ducts themselves.

5. GENERAL COMMON ELEMENTS. Each unit shall be entitled to an undivided percentage ownership interest in the common elements determined by the ratio which the area of the unit bears to the total area of all the units combined as shown on Exhibit

"B" attached hereto and made a part hereof. The general common elements consist of the following:

- 5.1 The land, pathways, fences, and grounds, if any.
- 5.2 Pipes, ducts, flues, chutes, conduits, wires and other utility installations to their outlets.
- 5.3 Roofs, foundations, bearing walls, perimeter walls, beams, columns and girders to the interior surfaces thereof.
- 5.4 The storage and maintenance areas and laundry rooms.
- 5.5 The elevator.
- 5.6 Hallways, stairways, entrances and exits, which are not part of the units or limited common elements.
- 5.7 All other elements of the building and the property necessary or convenient to their existence, maintenance and safety, or normally in common use, except as may be expressly designated herein as part of a unit or a limited common element.

6. LIMITED COMMON ELEMENTS. The following shall constitute limited common elements, the use of which shall be restricted to the units to which they pertain.

6.1 All decks adjoining the units which use them, as shown on the plans recorded simultaneously herewith.

7. USE OF PROPERTY: MAINTENANCE.

7.1 Each unit is to be used for residential purposes as described in the Bylaws. Additional limitations on use are contained in the Bylaws and the rules and regulations adopted pursuant to the Bylaws. Each unit owner shall be bound by each of the terms, conditions, limitations and provisions contained in such documents.

7.2 The necessary work to maintain, repair or replace the common elements shall be the responsibility of the Board of Directors of the Association and shall be carried out as provided in the Bylaws. If the mortgagee or beneficiary of any unit determines that the Board of Directors is not providing an adequate maintenance, repair and replacement program for the common elements, such mortgagee or beneficiary, at its option, may deliver a notice to the Board of Directors by delivering same to the registered agent, setting forth the particular defect which it believes exists in the maintenance, repair and

replacement program. If the specified defects are not corrected within ninety (90) days subsequent to receipt of such notice, the mortgagee or beneficiary, upon written notice to the registered agent that it is exercising its proxy rights thereunder, shall have the right to attend succeeding annual or special meetings of the Association and to cast a vote for each unit on which it holds a mortgage or deed of trust on all business coming before such meeting, which proxy rights shall continue until the defects listed on the notice are corrected.

8. COMMON PROFITS AND EXPENSES: VOTING

8.1 The common profits derived from and the common expenses of the common elements shall generally be distributed and charged to the owner of each unit according to the percentage of undivided interest of such unit in the common elements as determined by the ratio which the unit bears to the total area of all the units combined as shown in Exhibit "B" attached hereto and made a part hereof, except legal/accounting, garbage and common element area maintenance will be charged equally to units. Original purchasers of the units will be required to pay One Hundred Dollars (\$100.00) each as a reserve toward expenses. In addition, original unit owners shall pay One Hundred Dollars (\$100.00) each as a reserve for capital improvement plus a monthly fee to capital improvements and to maintenance thereafter, the specific amount of which is to be determined by the Board. Maintenance shall be defined as the day-to-day cleaning and up-keep of the common elements but shall not include capital improvements, replacement, and/or repair to structural elements.

8.2 Each unit owner shall be entitled to one vote in the affairs of the Association of unit owners for each unit owned by him/her. "Majority" or "majority of unit owners", as used in this Declaration or in the By-Laws, shall mean the owners of more than fifty percent (50%) of the then-existing units of the condominium.

9. SERVICE OF PROCESS. The name of the person to receive service of process is named in the Condominium Information Report which will be filed in accordance with ORS 100.250 (1).

10. ENCROACHMENTS. If any portion of the common elements now encroaches upon any unit, or if any unit now encroaches upon any other unit or upon any portion of the common elements, as a result of the construction of any building, or if any such encroachment shall occur hereafter as a result of settling or shifting of any building, a valid easement for the encroachment and for the maintenance of the same, so long as the building stands, shall exist. In the event any building, unit, adjoining

unit, or adjoining common element shall be partially or totally destroyed as a result of fire or other casualty or as a result of condemnation or eminent domain proceedings, and then rebuilt, encroachments of parts of the common elements upon any unit or of any other unit or upon any portion of the common elements, due to such rebuilding, shall be permitted, and valid easements for such encroachments and the maintenance thereof shall exist so long as the building shall stand.

11. RIGHTS OF MORTGAGEES AND BENEFICIARIES. The prior written approval of seventy-five percent (75%) of the holders of first mortgages or beneficiaries of first deeds of trust on units in the condominium (based upon one vote for each first mortgage or deed of trust owned) must be obtained for the following:

11.1 Abandonment or termination of the condominium regime;

11.2 Except as provided in Section 13.1, any change in the prorated interest or obligations of any individual unit for (a) the purpose of levying assessments or charges of allocating distributions of hazard insurance proceeds or condemnation awards, or (b) determining the prorated share of ownership of each unit in the common elements;

11.3 Partition or subdivision of any unit;

11.4 Abandonment, partition, subdivision, encumbrances, sale or transfer of the common elements. The granting of easements for public utilities or for other public purposes consistent with the intended use of the common elements by the condominium project shall not be deemed a transfer within the meaning of this clause; or,

11.5 Use of hazard insurance proceeds for losses to any condominium property, whether to units or to common elements, for other than the repair, replacement or reconstruction of such improvements, except as provided by statute in cases of substantial loss to the units and/or common elements of the condominium project.

12. ADOPTION OF BYLAWS, APPOINTMENT OF INTERIM BOARD, AND DESIGNATION OF MANAGER. Upon the execution and the filing of this Declaration, the Declarant shall adopt Bylaws for the Association of Unit Owners of Broadwaw View Condominiums, which Bylaws are attached hereto as Exhibit "C" and are filed simultaneously herewith. At the same time, Declarant will appoint an interim Board of Directors of the Association, which directors shall serve until their successors have been elected as provided in the Bylaws. Such interim board of directors may appoint a manager or managing agent for the condominiums on

behalf of the association of unit owners, and such manager or managing agent shall have complete authority to assume full control and responsibility for the management, operation and maintenance of the condominiums, at the expense of the association, from the date of its appointment. Each unit owner shall be a member of the association. Notwithstanding any other provision of this section, any management agreement or other contract providing for services by Declarant shall provide for termination on ninety (90) days' written notice and shall have a maximum contract term of three (3) years.

13. AMENDMENT.

13.1 Approval Required. Except as may otherwise be provided in this Declaration or by the Oregon Condominium Act, this Declaration may be amended if such amendment is approved by seventy-five percent (75%) of the voting power of the unit owners. No amendment may change the size, location, percentage interest in the common elements, share of common profits or expenses, or voting power of any unit unless such amendment has been approved by the owners of the affected unit and the holders of any mortgage or trust deed on such unit. If required by law, any amendment to this Declaration shall be approved by the Real Estate Commissioner. Sections 11 and 7.2 may not be amended without the written consent of all holders of first mortgages and beneficiaries of first deeds of trust on units in the condominiums.

13.2 Recordation. The amendment shall be effective upon recordation of the Declaration as amended or of the amendment thereto, certified to by the chairman and secretary of the Association and approved by the County Assessor and the Real Estate Commissioner, in the Deed Records of Multnomah County.

14. ASSOCIATION POWERS. The Association shall have those powers granted under the Bylaws and the Oregon Condominium Act and subject to ORS 100.405(5), shall have the authority to execute, acknowledge, deliver and record on behalf of the unit owners leases, easements, rights of way, licenses and other similar interests affecting the general common elements.

15. SEVERABILITY. The determination of invalidity, by any court, of any provision or restriction imposed by this Declaration or the Bylaws, or of any provision or restriction thereof, or of any part of such restriction or provision, shall not impair or affect in any manner the validity, enforceability, or effect of the rest of this Declaration or the Bylaws, and all of the terms thereof shall be severable.

///

///  
///  
///

IN WITNESS WHEREOF, Declarant has caused this Declaration to be executed this 21 day of August, 1995.

Kings Hill Project, L.L.C., an Oregon Limited Liability Company by Port West Properties, Inc., its Managing Agent

By: Gregory P. Dolinajec  
Gregory P. Dolinajec, President

Acknowledged.

STATE OF OREGON, )  
County of Multnomah ) ss.

This instrument was acknowledged before me on AUGUST 21, 1995, by Gregory P. Dolinajec as President of Port West Properties, Inc., managing agent of Kings Hill Project, L.L.C., an Oregon Limited Liability Company.

Susan Sadler  
Notary Public for Oregon  
My commission expires: 3-7-99



By Richard B. Hill  
County Assessor

By Barry B...  
County Tax Collector

The foregoing Declaration is approved pursuant to ORS 100.110 this 6th day of September, 1995.

SCOTT W. TAYLOR  
Real Estate Commissioner

By: Stan F. Mansfield

KINGS HILL CONDOMINIUMS DECLARATION  
MAY 24, 1995

7

7



Exhibit "A"  
Kings Hill Condominiums  
Declaration

LEGAL DESCRIPTION

The premises are in Multnomah County, and are described as follows:

Situated in the Southwest quarter of Section 33, Township 1 North, Range 1 East, Willamette Meridian, City of Portland, Multnomah County, Oregon, and being more particularly described as follows:

BEGINNING at the Southeast corner of Block 6 of JOHNSON'S ADDITION TO THE CITY OF PORTLAND, recorded in Plat Book 1 at Page 81 of the Multnomah County Records, said point being the initial point of this plat and from which the Northwest corner of THE LIPMAN HOUSE CONDOMINIUM bears West 300.00 feet and South 60.00 feet and is monumented with a 5/8-inch iron rod with a yellow plastic cap marked "R.A. Lawrence" and further from said initial point a brass plug in lead South 4.00 feet and East 4.00 feet; thence from the initial point West along the South line of said Block 6, a distance of 67.00 feet from which a brass screw in concrete bears South 4.00 feet; thence North along a line which is 67.00 feet West of and parallel with the East line of said Block 6, 100.00 feet, from which I found a 5/8 inch iron rod south 0.18 feet; thence East 67.00 feet to the East line of said Block 6 from which a lead plug with a punch mark bears East 5.08 feet and South 0.14 feet; thence South along the East line of said Block 6, 100.0 feet to the initial point and point of beginning.

(According to a survey under the direction of G. Robert Taylor, Registered Professional Land Surveyor)

8

KINGS HILL CONDOMINIUMS DECLARATION  
MAY 24, 1995

8

**Exhibit "B"  
Kings Hill Condominiums  
Declaration**

UNIT	GENERAL DESCRIPTION BD/BA	OWNERSHIP PERCENTAGE	APPROXIMATE SQUARE FOOTAGE
1	3/1	7.084	1102
2	3/1	6.653	1035
Studio A	Studio/1	2.957	460
3	2/1	6.769	1053
4	1/1	3.902	607
5	2/1	6.306	981
6	1/1	5.368	835
7	1/1	5.599	871
8	2/1	6.769	1053
9	1/1	3.902	607
10	2/1	6.306	981
11	1/1	5.368	835
12	1/1	5.599	871
14	2/1	6.506	1012
15	1/1	3.902	607
16	2/1	6.043	940
17	1/1	5.368	835
18	1/1	5.599	871
<hr/>		<hr/>	<hr/>
18		100.00	15,556

453

STATE OF OREGUN }  
Multnomah County }

I, a Deputy for the Recorder of Conveyances, in and for said County, do hereby certify that the instrument of writing was received for record and recorded in the record of said County.

95 SEP 27 PM 2:37

RECORDING SECTION  
MULTNOMAH CO. OREGON

95 118109

Witness my hand and seal of office this 27th day of September, 1995.  
Recorder of Conveyances

*C Swick*

Deputy

KINGS HILL CONDOMINIUMS DECLARATION  
MAY 24, 1995

9

9